

**NOTES**

**MATERIAL:** -DIECAST ALUMINUM ALLOY,  
-FOUR 6-32 Phillips screws

WATERPROOFING KIT AVAILABLE  
PART # 1590TG  
THE GASKET KIT WILL AFFORD  
PROTECTION AGAINST LIQUID TO  
NEMA 4 AND IP65 LEVELS.

THIS ENCLOSURE IS ALSO  
AVAILABLE IN BLACK AND GRAY  
TEXTURE FINISH.

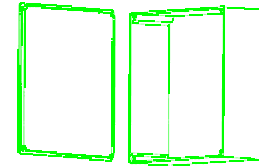

**3D VIEW**  
(NOT TO SCALE)

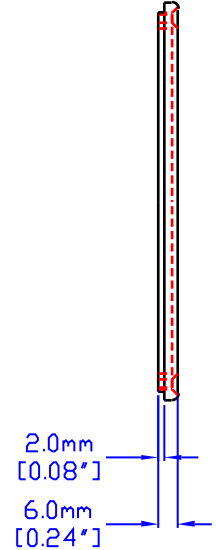
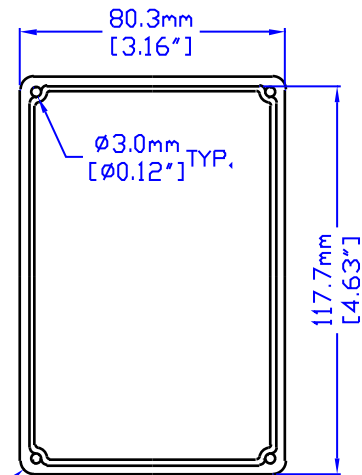
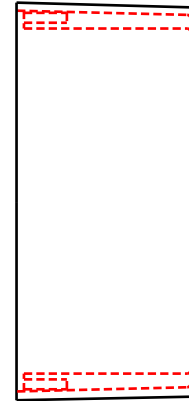
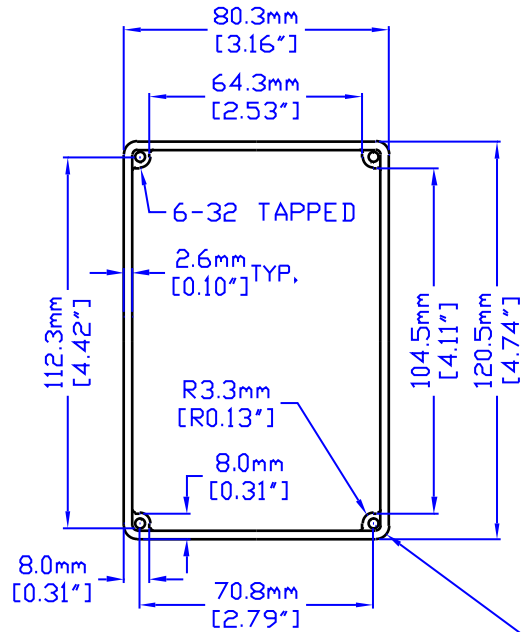
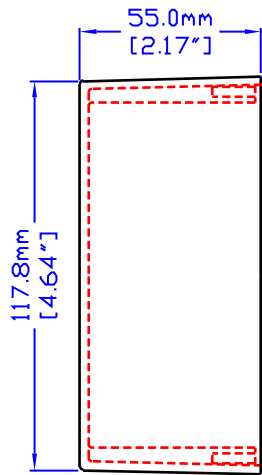
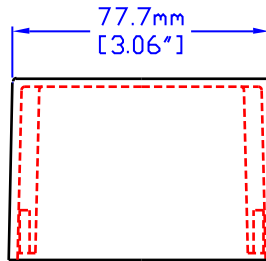

**VIEW INSIDE LID**

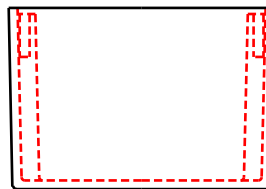

**VIEW OF BOX (LID REMOVED)**



**HAMMOND MANUFACTURING**

**1590T**

CANADA - PH (519) 886 7170 - FAX (519) 886 8311  
U.S.A. - PH (716) 631 5700 - FAX (716) 631 1156